

In-tensive Move

Jouni Leino

inno



Leino's In-tensive Move Table is a compact, modular solution designed to enhance flexibility in dynamic workspaces. With a convenient folding mechanism, it saves space when not in use, while wheels allow for easy mobility. The table can be equipped with electric units for added functionality, and a linking device enables the creation of larger table configurations for meetings or collaborative spaces. This versatile design makes it ideal for modern, adaptable work environments.

Height: 720
Width: 1600 | 1900 | 2200
| 2100 | 2400 | 2700
Depth: 800-1200



AR- QR code

DESIGNER

Jouni Leino

The designer, interior architect Jouni Leino founded his design studio in 1992 and has since developed projects mostly for public spaces and offices. His co-operation with Inno has been long and successful. He has also worked as professor and lecturer for the West-Finland Design Center MUOVA, the Helsinki University of Art and Design and the Dublin Institute of Technology.



FLAPS
- Folding

CABLE TRAY 1500/1420

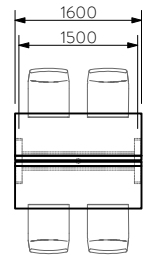
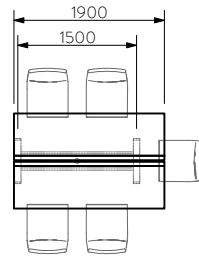
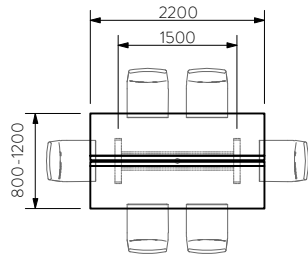

CABLE TRAY 2000/1920

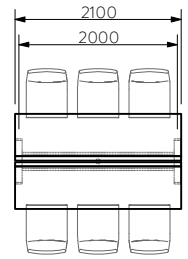
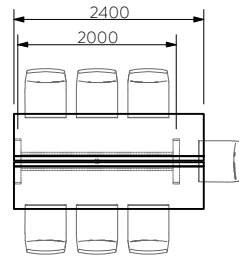
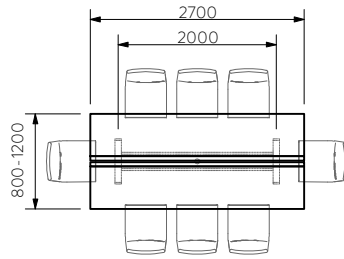

NO FLAPS
- Fixed (not folding)

CABLE TRAY 1500/1420

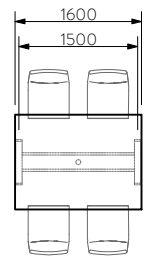
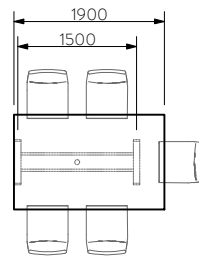
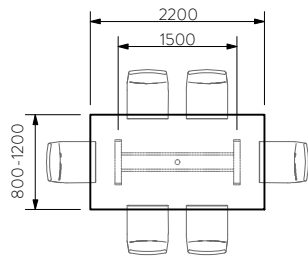

CABLE TRAY 2000/1920

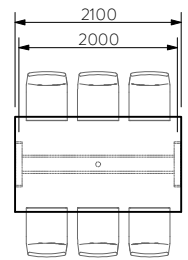
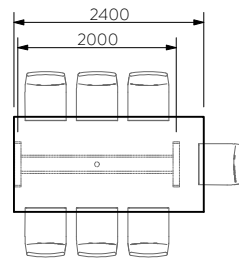
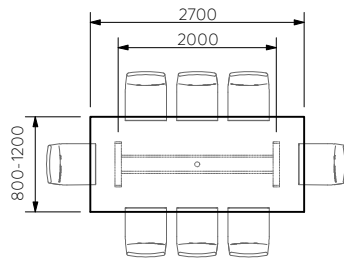

LEGS

END LEG

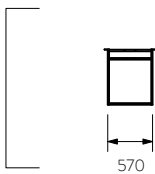

ADD-ONS

END WOOD COVER

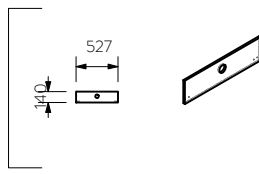

SUPPORT BEAMS

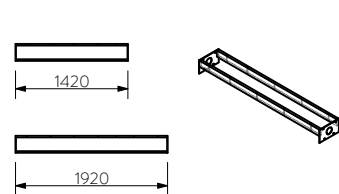

**SINGLE UNITS
CABLE TRAY 1500**

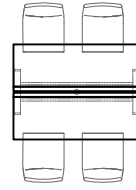
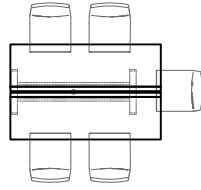
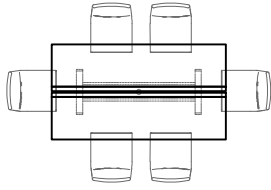

**SINGLE UNITS
CABLE TRAY 2000**

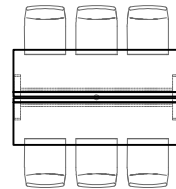
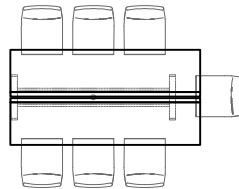
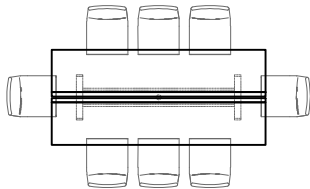

**MODULARITY
LINEAR**

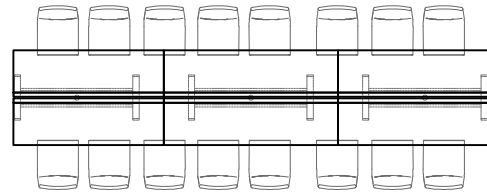
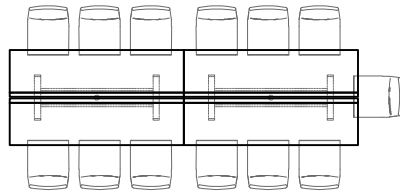

**MODULARITY
GROUP**

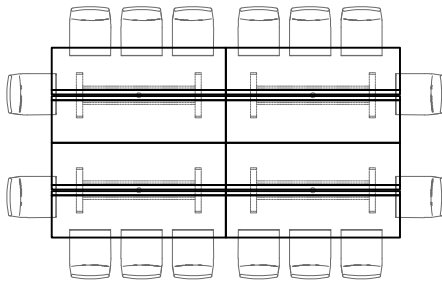

OPEN

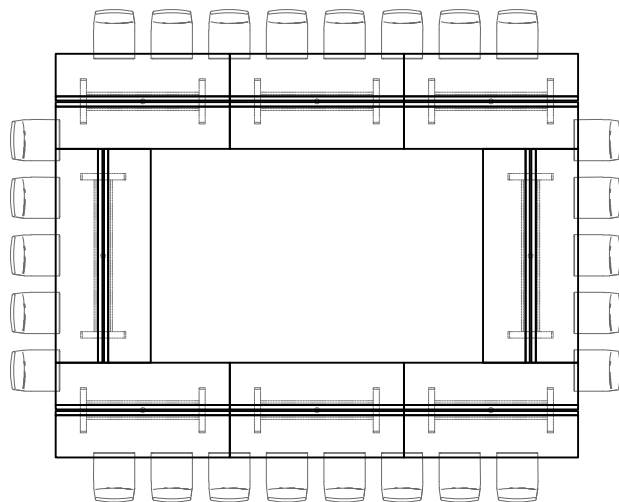

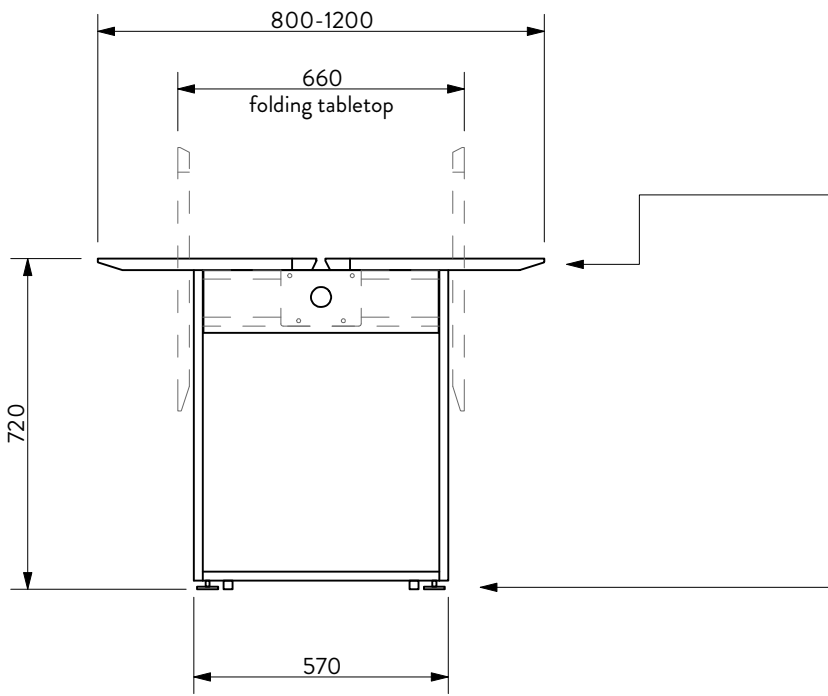

EDGES:

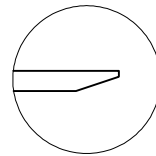

SVR 26mm

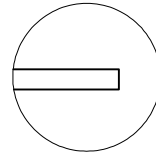

SR 26mm

MOBILITY

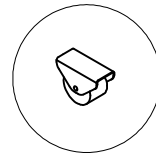

wheels

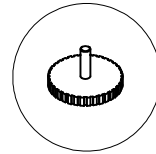

adjustable
gliders

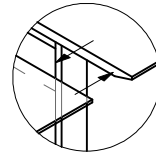

linking device

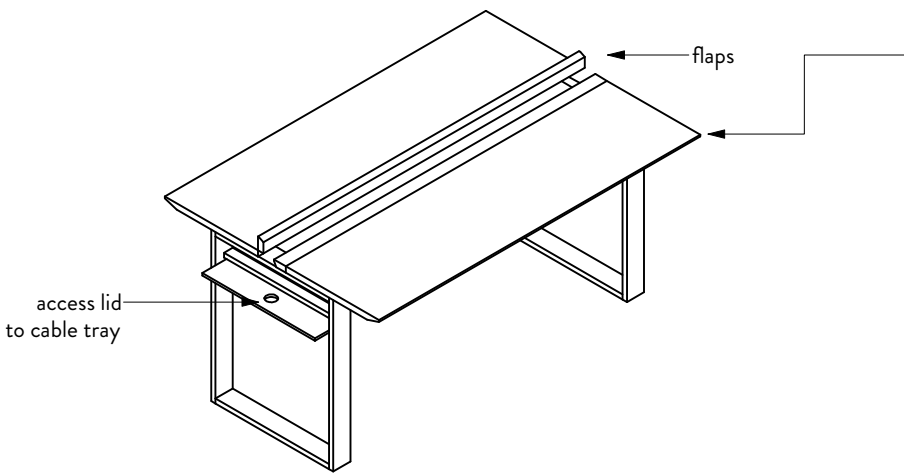

CABLE MANAGEMENT

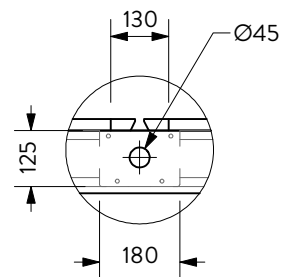

flaps
&
cable-tray

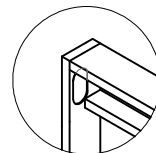

cut-out in leg for
cable management

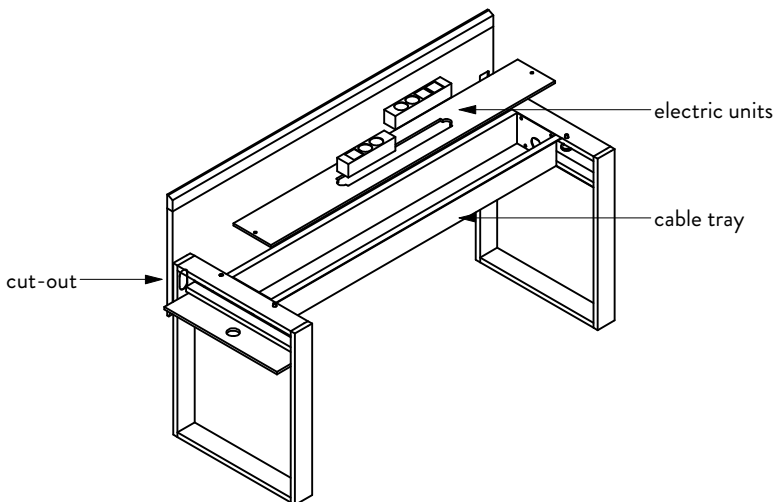

ELECTRIFICATION

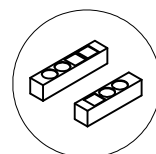

electric units:
PC / USB / HDMI
VGA / RJ45